

* PCB 1.60mm THICKNESS

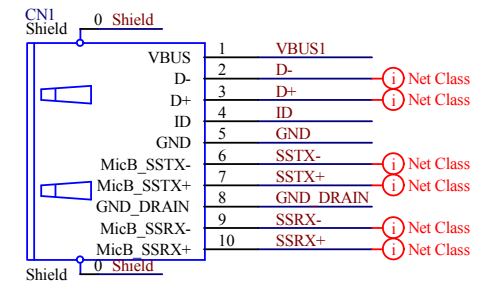

Micro USB3.0 Type B Female

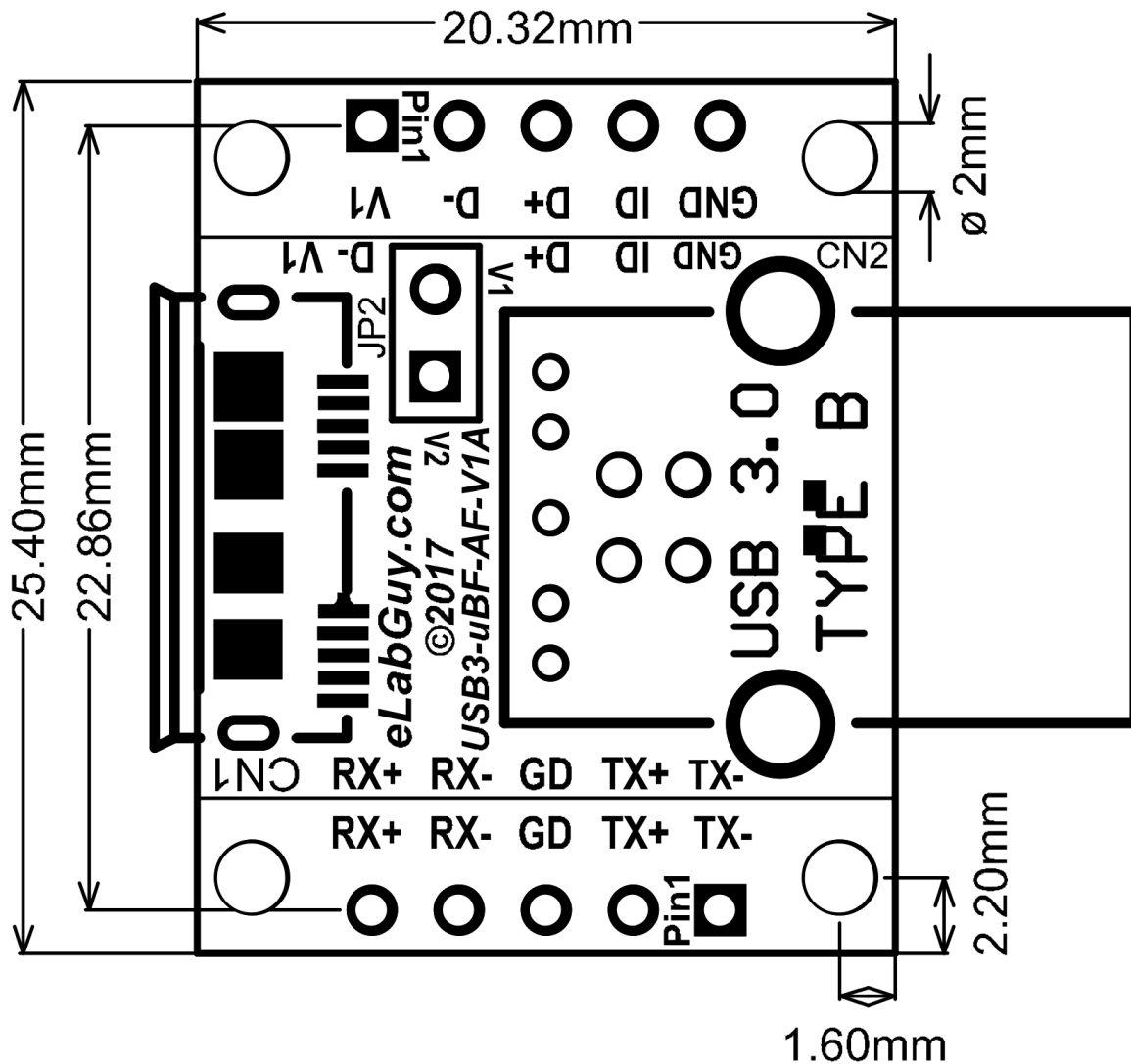
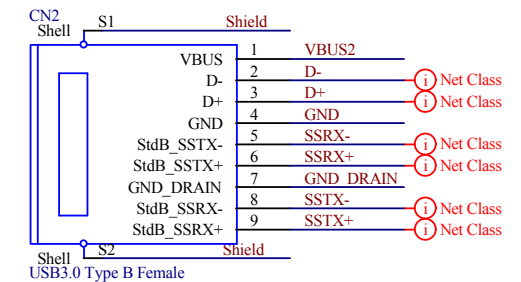

USB3.0 Type B Female

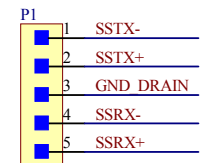
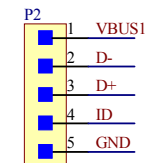
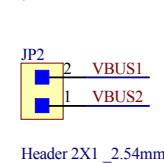
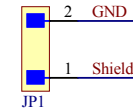

Header 2X1 _2.54mm

Header 5X1 _2.54mm

Header 5X1 _2.54mm



Title		
USB3.0 Micro B Female To Type A Female Pass Through		
Size	Number	Revision
A4	USB3uBF-AF-V1A	1A
Date:	11/30/2017	Sheet of
File:	C:\Users\...USB3-uBF-AF-V1A Drawing	Created By: www.eLabGuy.com