

**\*PCB 1.6mm Thickness**

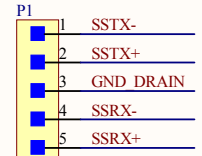
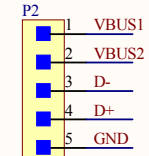
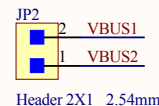
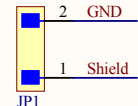
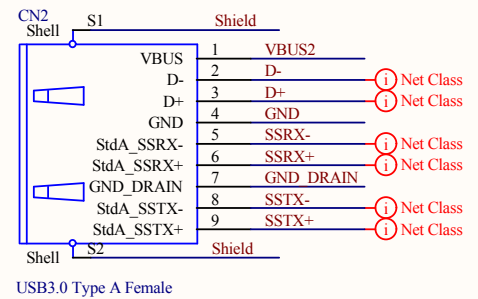
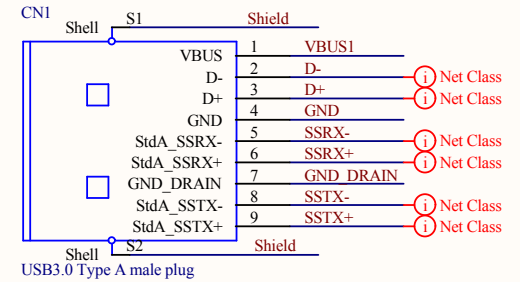
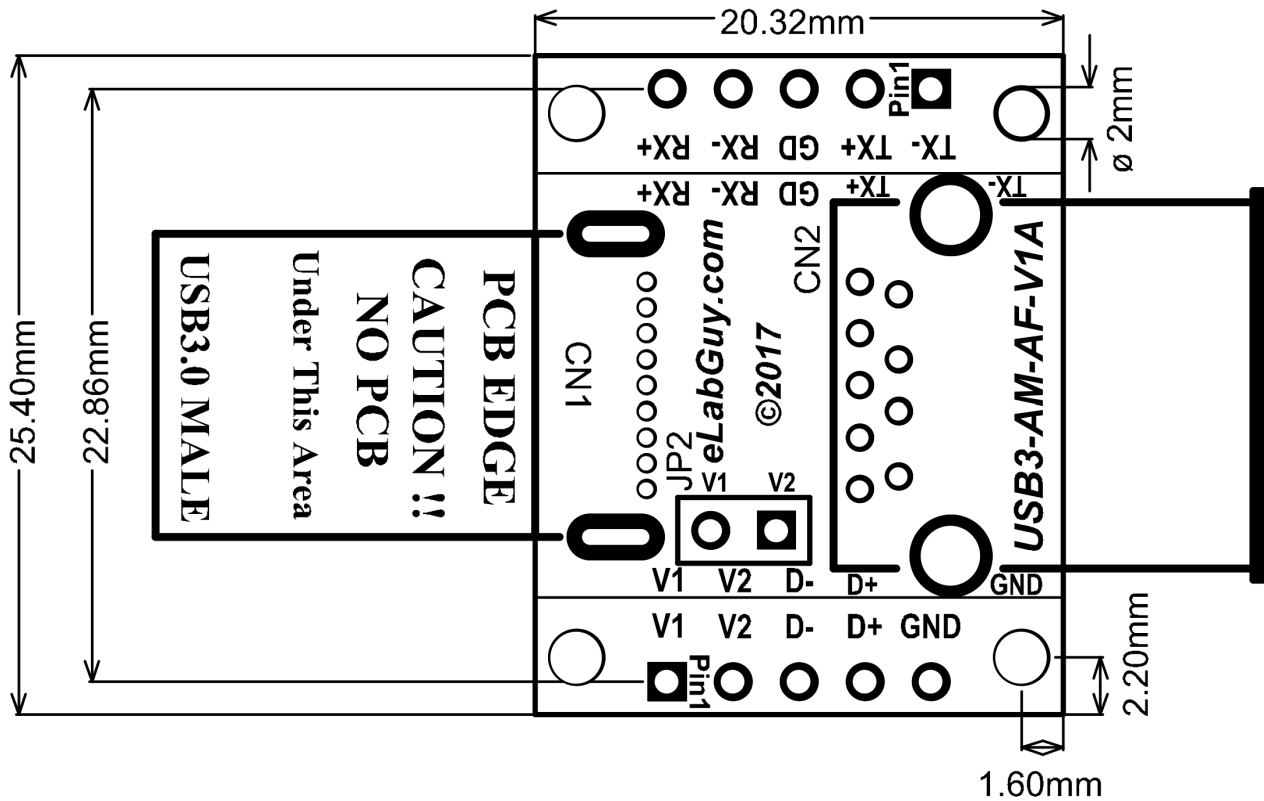

Title			<b>USB3.0 A Male To A Female Breakout</b>		
Size	Number	Revision			
A4	<b>USB3-AM-AF-V1A</b>	<b>1A</b>			
Date:	10/8/2017	Sheet of			
File:	C:\Users\...USB3-AM-AF-V1A Drawing	Drawn By:	www.eLabGuy.com		