

* PCB 1.60mm THICKNESS

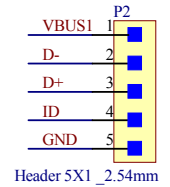
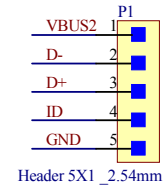
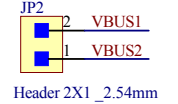
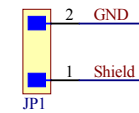
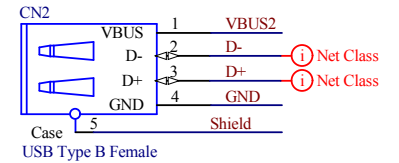
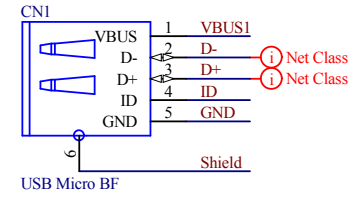
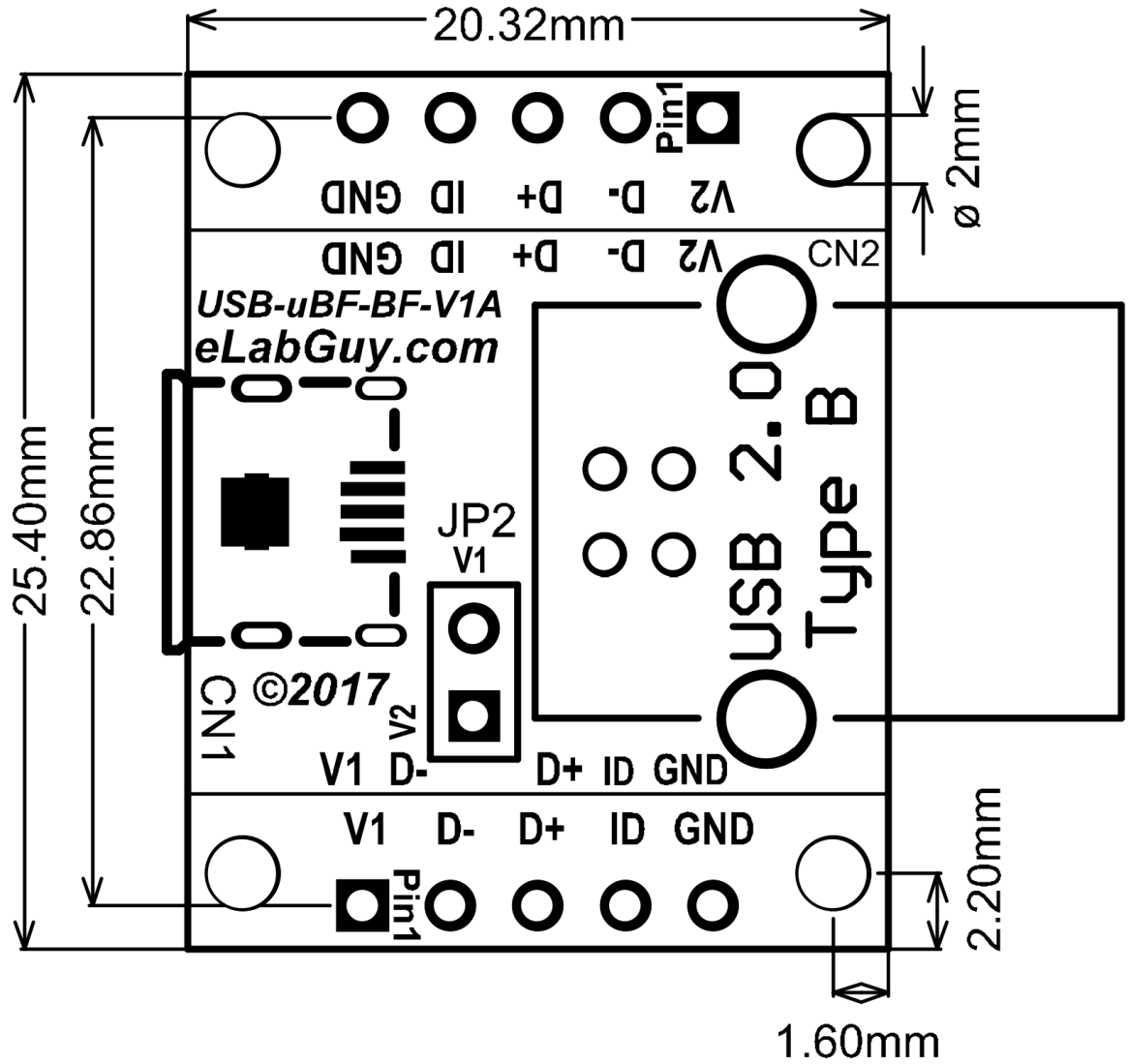

Title		
USB2.0 Micro Type B Female to Type B Female Pass Through		
Size	Number	Revision
A4	USB-uBF-BF-V1A	1A
Date:	11/30/2017	Sheet of
File:	C:\Users\...USB-uBF-BF-V1A Drawing.SchDoc	
		Download By: www.eLabGuy.com