

* PCB 1.60mm THICKNESS

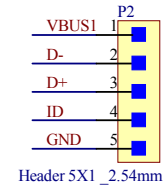
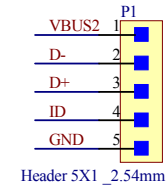
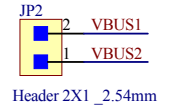
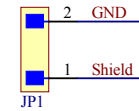
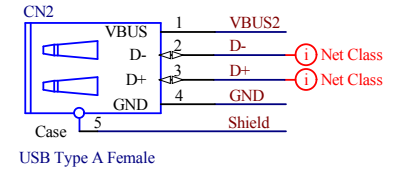
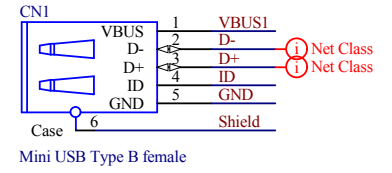
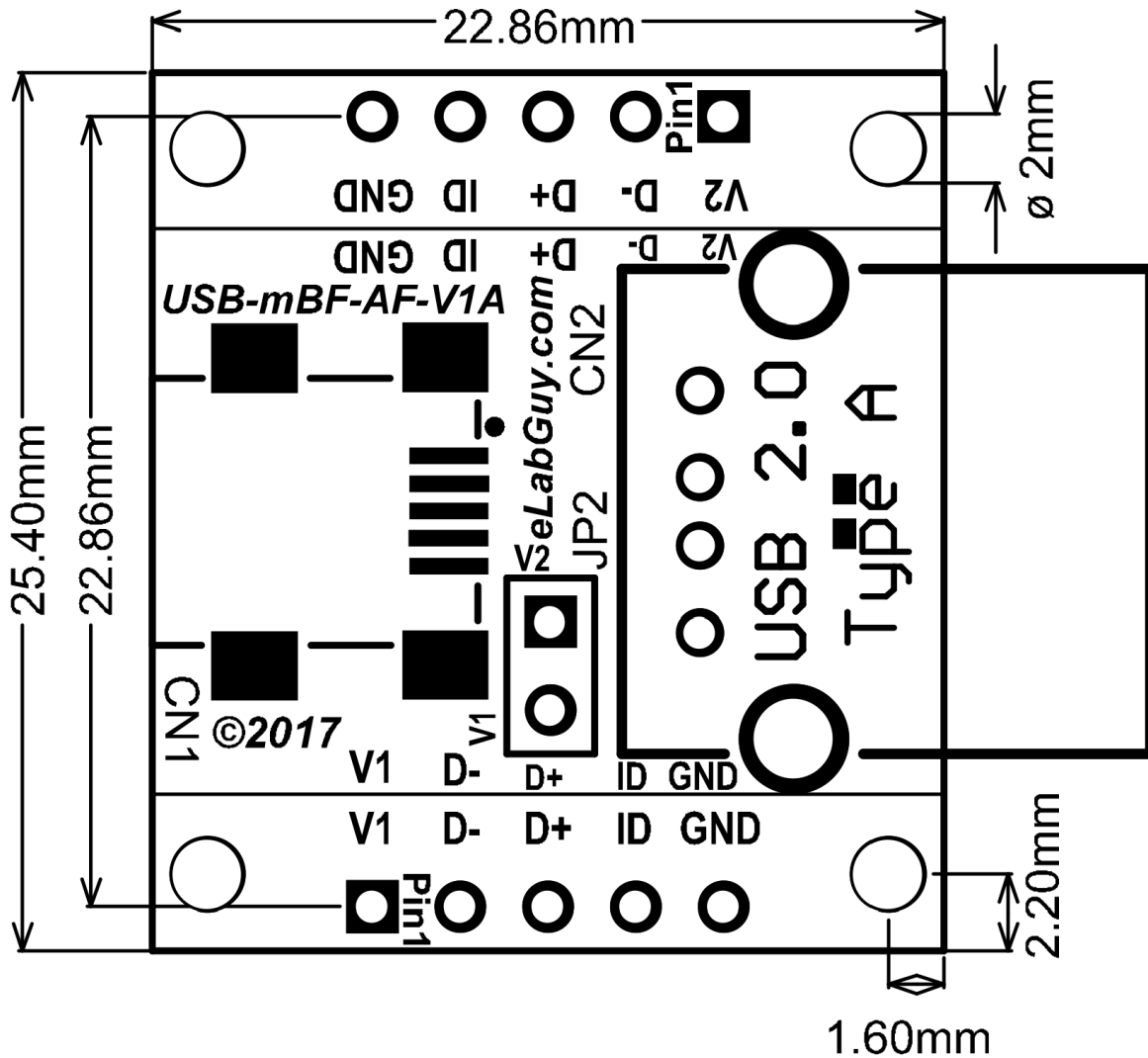

Title USB2.0 Mini Type B Female to Type A Female Pass Through		
Size A4	Number USB-mBF-AF-V1A	Revision 1A
Date: 11/30/2017	Sheet of	
File: C:\Users\...USB-mBF-AF-V1A Drawing.SchDoc By: www.eLabGuy.com		